

## Description

The AP9234L family is a single-chip protection solution specially designed for 1-cell Li<sup>+</sup> rechargeable battery pack application.

The AP9234L includes a 1-cell high accuracy Li<sup>+</sup> battery protection chip and dual N-CH, ultra low R<sub>SS(ON)</sub> MOSFET with common drain.

The AP9234L provides rich battery protection features and can turn-off the N-Channel MOSFET by detecting overcharge voltage/current, overdischarge voltage/current, or load short circuit. AP9234 has built-in fixed delay time to save external components.

The AP9234L integrates highly accurate detection circuits and can compensate according to internal MOSFET R<sub>SS(ON)</sub> performance to ensure extremely high charge/discharge current accuracy under both room and full temperature.

AP9234L is available in U-DFN2535-6 package.

## Features

- High-Voltage CMOS Process, up to 24V (V<sub>DD</sub> to V<sub>M</sub>)
- Low Quiescent Current (+25°C )
  - Operation Mode: 3.0μA Typ. V<sub>DD</sub> = 3.5V
  - Power-Down Mode: 0.01μA Typ.
- High Accuracy Voltage Detection (+25°C )
  - Overcharge Detection Voltage: 3.5V to 4.5V (5mV/step)  
Accuracy -15mV, +25mV
  - Overcharge Release Voltage: 3.4V to 4.4V (50mV/step)  
Accuracy ±50mV
  - Overdischarge Detection Voltage: 2.0V to 3.4V (10mV/step)  
Accuracy ±35mV
  - Overdischarge Release Voltage: 2.7V to 3.4V (40mV/step)  
Accuracy ±65mV (No Power-down Mode)
  - Discharge Overcurrent Detection Voltage: 0.03V to 0.19V  
(10mV/step) Accuracy ±12mV
  - Short Current Detection Voltage: 0.16V to 0.32V (50mV/step)  
Accuracy ±50mV
  - Charge Overcurrent Detection Voltage: -0.19V to -0.03V  
(10mV/step) Accuracy ±12mV
  - Over Charger Detection Voltage: 8.0V (fixed) Accuracy ±2.0V
  - Over Charger Release Voltage: 7.3V (fixed) Accuracy ±2.0V
- High Accuracy Current Detection (+25°C )  
Charge/Discharge current limit: ±2A
- Built-in Delay Time (+25°C ), Accuracy ±20%
- Auto-wake-up Function (No Power Down)
- 0V Battery Charge Selectable (Permission or Inhibition)
- Overcharge Protection Mode Selectable (Auto Release or Latch)
- **Totally Lead-Free & Fully RoHS Compliant (Notes 1 & 2)**
- **Halogen and Antimony Free. "Green" Device (Note 3)**

Notes: 1. No purposely added lead. Fully EU Directive 2002/95/EC (RoHS) & 2011/65/EU (RoHS 2) compliant.  
 2. See [http://www.diodes.com/quality/lead\\_free.html](http://www.diodes.com/quality/lead_free.html) for more information about Diodes Incorporated's definitions of Halogen- and Antimony-free, "Green" and Lead-free.  
 3. Halogen- and Antimony-free "Green" products are defined as those which contain <900ppm bromine, <900ppm chlorine (<1500ppm total Br + Cl) and <1000ppm antimony compounds.

## Pin Assignments

(Top View)

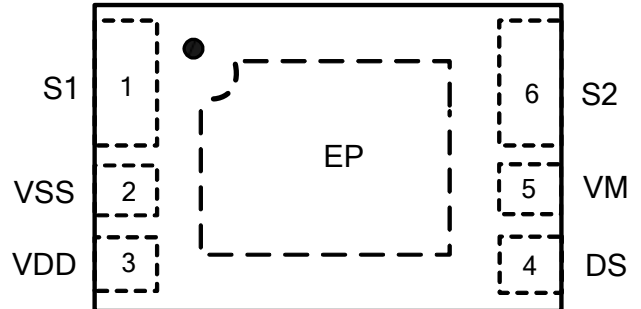

U-DFN2535-6

## Applications

- Li<sup>+</sup> Rechargeable Battery Pack

**Typical Applications Circuit** (Note 4)

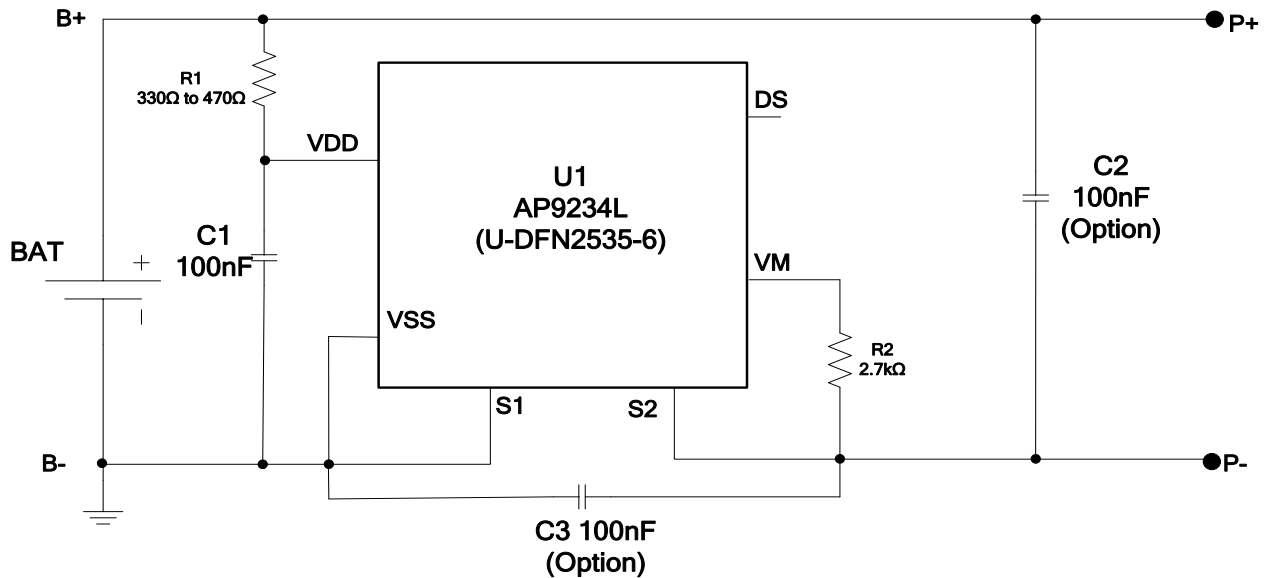

Note: 4. R1 and C1 are used to stabilize the supply voltage of the AP9234L. The recommended range of R1 value is 330Ω to 470Ω and C1 value is 10nF to 1000nF, typical value is 100nF. R2 should be connected between P- to VM sense terminal to monitor the status of charger and the charge/discharge current. The R2 should be between 300Ω and 4kΩ, typical value is 2.7kΩ. R1 and R2 are also used as current limit resistors if the battery or charger is connected reversely. Polarity reversing may cause the power consumption of R1 and R2 to go over their power dissipation rating, therefore R1 and R2 values should be selected appropriately for the actual application. If R2 is more than 4kΩ resistor, charge may not be off due to the voltage drop on R2.

For power down mode (please contact Diodes Inc. sales team), when first connecting AP9234L system board to the battery, it is necessary to use charger or to short P- to the battery negative polarity. Once the AP9234L is activated, the charger or connection can be removed, otherwise the battery cannot discharge current through system board.

The values selected should follow the recommended typical range mentioned above.

**Pin Descriptions**

Pin Number	Pin Name	Function
1	S1	Source pin of discharging MOSFET, connecting this pin to battery negative pole
2	V <sub>SS</sub>	Negative power input.
3	V <sub>DD</sub>	Positive power supply pin, connecting this pin to battery positive pole through R1
4	DS	Test Pin, leave it open
5	V <sub>M</sub>	Charger negative input pin, short this pin to S2 pin through R2
6	S2	Source pin of charging MOSFET, connecting this pin to charge negative input
EP	D	Exposed PAD is common drain of charge and discharge MOSFET, so in PCB layout, prefer to use large copper area to cover this pad for better thermal dissipation, then leave it open

**Functional Block Diagram**

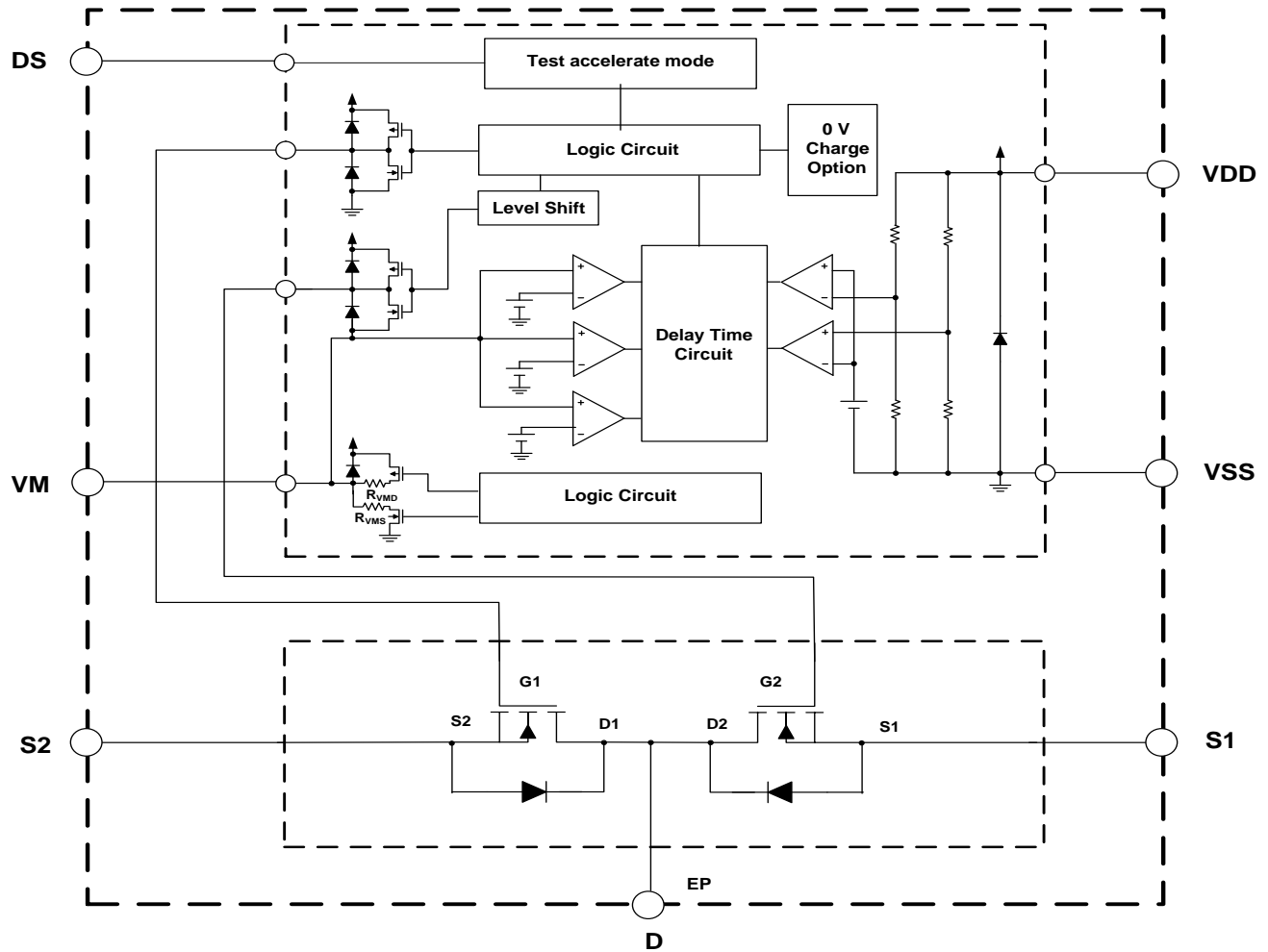

**Absolute Maximum Ratings** (Notes 5 & 6)

Symbol	Parameter	Rating	Unit
V <sub>DD</sub>	Supply Voltage (Between V <sub>DD</sub> and V <sub>SS</sub> )	-0.3 to 12	V
V <sub>DS</sub>	DS Terminal Input Voltage	-0.3 to V <sub>DD</sub> +0.3	V
V <sub>DM</sub>	Charge Input Voltage (Between V <sub>DD</sub> and V <sub>M</sub> for Protection Chip)	-0.3 to 24	V
V <sub>DSS</sub>	MOSFET Drain-to-Source Voltage	24	V
V <sub>GSS</sub>	MOSFET Gate-to-Source Voltage	±12	V
I <sub>D</sub>	Continuous Drain Current, V <sub>GS</sub> =4.5V, T <sub>A</sub> = +25°C	9.0	A
	Continuous Drain Current, V <sub>GS</sub> =4.5V, T <sub>A</sub> = +70°C	7.1	A
T <sub>J</sub>	Maximum Junction Temperature	+150	°C
T <sub>STG</sub>	Storage Temperature Range	-65 to +150	°C

Notes: 5. Stresses beyond those listed under Absolute Maximum Ratings may cause permanent damage to the device. These are stress ratings only and functional operation of the device at these conditions is not implied. Exposure to absolute-maximum-rated conditions for extended periods may affect device reliability.

6. Ratings apply to ambient temperature at +25°C. The JEDEC High-K board design used to derive this data was a 2 inch x 2 inch multilayer board with 2-ounce internal power and ground planes and 2-ounce copper traces on the top and bottom of the board.

## Recommended Operating Conditions

Symbol	Parameter	Min	Max	Unit
V <sub>DD</sub>	Supply Voltage (between V <sub>DD</sub> and V <sub>SS</sub> )	1.5	5.5	V
V <sub>DM</sub>	Charge Input Voltage (between V <sub>DD</sub> and V <sub>M</sub> )	-0.3	5.5	V
T <sub>A</sub>	Operating Ambient Temperature	-40	+85	°C

## Electrical Characteristics (T<sub>A</sub> = +25°C, V<sub>DD</sub> = 3.5V, V<sub>SS</sub> = 0V, R1 = 220Ω, R2 = 1.0kΩ, C1 = 100nF, unless otherwise specified.)

Symbol	Parameter	Conditions	Min	Typ	Max	Units
V <sub>CU</sub>	Overcharge Detection Voltage	V <sub>M</sub> =0V	V <sub>CU</sub> - 0.015	V <sub>CU</sub>	V <sub>CU</sub> + 0.025	V
V <sub>CL</sub>	Overcharge Release Voltage	V <sub>CL</sub> ≠ V <sub>CU</sub>	V <sub>CL</sub> - 0.050	V <sub>CL</sub>	V <sub>CL</sub> + 0.050	V
		V <sub>CL</sub> = V <sub>CU</sub>	V <sub>CL</sub> - 0.015	V <sub>CL</sub>	V <sub>CL</sub> + 0.025	V
V <sub>DL</sub>	Overdischarge Detection Voltage	V <sub>M</sub> =0V	V <sub>DL</sub> - 0.035	V <sub>DL</sub>	V <sub>DL</sub> + 0.035	V
V <sub>DU</sub>	Overdischarge Release Voltage	V <sub>DU</sub> ≠ V <sub>DL</sub>	V <sub>DU</sub> - 0.065	V <sub>DU</sub>	V <sub>DU</sub> + 0.065	V
		V <sub>DU</sub> = V <sub>DL</sub>	V <sub>DU</sub> - 0.035	V <sub>DU</sub>	V <sub>DU</sub> + 0.035	V
V <sub>DOC</sub>	Discharge Overcurrent Detection Voltage	V <sub>DD</sub> = 3.5V	V <sub>DOC</sub> -0.012	V <sub>DOC</sub>	V <sub>DOC</sub> +0.012	V
V <sub>SHORT</sub>	Load Short Detection Voltage	V <sub>DD</sub> = 3.5V	V <sub>SHORT</sub> -0.100	V <sub>SHORT</sub>	V <sub>SHORT</sub> +0.100	V
V <sub>COC</sub>	Charge Overcurrent Detection Voltage	V <sub>DD</sub> = 3.5V	V <sub>COC</sub> -0.012	V <sub>COC</sub>	V <sub>COC</sub> +0.012	V
I <sub>CC</sub>	Current Consumption during Operation	V <sub>DD</sub> =3.5V, V <sub>M</sub> =0V	—	3	4.5	μA
I <sub>STB</sub>	Current Consumption at Standby	V <sub>DD</sub> =1.8V, V <sub>M</sub> Pin Floating	—	3.5	5.5	μA
R <sub>VMD</sub>	Resistance between V <sub>M</sub> Pin and V <sub>DD</sub> Pin	V <sub>DD</sub> =1.8V, V <sub>M</sub> =0V	150	300	500	kΩ
R <sub>VMS</sub>	Resistance between V <sub>M</sub> Pin and V <sub>SS</sub> Pin	V <sub>DD</sub> =3.5V, V <sub>M</sub> =1.0V	10	30	50	kΩ
V <sub>0CHA</sub>	0V Battery Charge Starting Charge Voltage	0V battery charging "available"	1.2	—	—	V
V <sub>0INH</sub>	0V Battery Charge Inhibition Battery Voltage	0V battery charging "unavailable"	—	—	0.45	V
V <sub>OVCHG</sub>	Overvoltage Charge Detection Voltage	V <sub>DD</sub> =3.5V	6.0	8.0	10.0	V
V <sub>OVCHGR</sub>	Overvoltage Charge Release Voltage	V <sub>DD</sub> =3.5V	5.3	7.3	9.3	V
t <sub>CU</sub>	Overcharge Detection Delay Time	V <sub>CC</sub> =3.6->4.5V	800	1,000	1,200	ms
t <sub>CUR</sub>	Overcharge Release Delay Time	V <sub>M</sub> =0.0V	1.6	2	2.4	ms
t <sub>DL</sub>	Overdischarge Detection Delay Time	V <sub>CC</sub> =3.6->2.0V	92	115	138	ms
t <sub>DLR</sub>	Overdischarge Release Delay Time	V <sub>M</sub> =0.0V	1.6	2	2.4	ms
t <sub>DOC</sub>	Discharge Overcurrent Detection Delay Time	V <sub>CC</sub> =3.6V	8	10	12	ms
t <sub>DOCR</sub>	Discharge Overcurrent Release Delay Time	V <sub>M</sub> =0.0V	1.6	2.0	2.4	ms
t <sub>SHORT</sub>	Load Short Detection Delay Time	V <sub>CC</sub> =3.6V	288	360	432	μs
t <sub>COC</sub>	Charge Overcurrent Detection Delay Time	V <sub>CC</sub> =3.6V	8	10	12	ms
t <sub>COCR</sub>	Charge Overcurrent Release Delay Time	V <sub>M</sub> =0.0V	1.6	2	2.4	ms

### Electrical Characteristics (continued, Notes 7 & 8)

( $T_A = +25^\circ\text{C}$ ,  $V_{DD} = 3.5\text{V}$ ,  $V_{SS} = 0\text{V}$ ,  $R_1 = 220\Omega$ ,  $R_2 = 1.0\text{k}\Omega$ ,  $C_1 = 100\text{nF}$ , unless otherwise specified.)

Symbol	Parameter	Conditions	Min	Typ	Max	Units
$I_{DSS}$	Zero Gate Voltage Drain Current	$V_{DS} = 20\text{V}$ , $V_{GS} = 0$	—	—	1.0	$\mu\text{A}$
$R_{SS(ON)1}$	Static Source-Source On-Resistance 1	$V_{DD} = 4.0\text{V}$ , $I_D = 1.0\text{A}$	10.4	13	15.2	$\text{m}\Omega$
$R_{SS(ON)2}$	Static Source-Source On-Resistance 2	$V_{DD} = 3.9\text{V}$ , $I_D = 1.0\text{A}$	10.6	13.2	15.5	$\text{m}\Omega$
$R_{SS(ON)3}$	Static Source-Source On-Resistance 3	$V_{DD} = 3.0\text{V}$ , $I_D = 1.0\text{A}$	11.1	13.9	16.3	$\text{m}\Omega$
$V_{SD}$	Diode Forward Voltage	$V_{GS} = 0\text{V}$ , $I_S = 1\text{A}$	—	0.75	1.0	V
$I_{charge1}$	Charge Current Limit 1	$V_{CC} = 4.0\text{V}$	-4.01	-5.62	-8.17	A
$I_{charge2}$	Charge Current Limit 2	$V_{CC} = 3.9\text{V}$	-3.94	-5.53	-8.02	A
$I_{charge3}$	Charge Current Limit 3	$V_{CC} = 3.0\text{V}$	-3.74	-5.25	-7.66	A
$I_{discharge1}$	Discharge current limit 1	$V_{CC} = 4.0\text{V}$	3.42	4.92	7.31	A
$I_{discharge2}$	Discharge current limit 2	$V_{CC} = 3.9\text{V}$	3.35	4.85	7.17	A
$I_{discharge3}$	Discharge current limit 3	$V_{CC} = 3.0\text{V}$	3.19	4.60	6.85	A

Notes: 7. In case of Gate-Source voltage of charging MOSFET is 0V. In case of Gate-Source voltage of discharging MOSFET is 0V.  
 8. These specifications are guaranteed by design - will not be tested in production.

**Electrical Characteristics** (continued)

 (T<sub>A</sub> = -40°C to +85°C, V<sub>DD</sub> = 3.5V, V<sub>SS</sub> = 0V, R1 = 220Ω, R2 = 1.0kΩ, C1 = 100nF, unless otherwise specified.)

Symbol	Parameter	Conditions	Min	Typ	Max	Units
V <sub>CU</sub>	Overcharge Detection Voltage	V <sub>M</sub> =0V	V <sub>CU</sub> - 0.050	V <sub>CU</sub>	V <sub>CU</sub> + 0.040	V
V <sub>CL</sub>	Overcharge Release Voltage	V <sub>CL</sub> ≠ V <sub>CU</sub>	V <sub>CL</sub> - 0.070	V <sub>CL</sub>	V <sub>CL</sub> + 0.060	V
		V <sub>CL</sub> = V <sub>CU</sub>	V <sub>CL</sub> - 0.050	V <sub>CL</sub>	V <sub>CL</sub> + 0.040	V
V <sub>DL</sub>	Overdischarge Detection Voltage	V <sub>M</sub> =0V	V <sub>DL</sub> - 0.080	V <sub>DL</sub>	V <sub>DL</sub> + 0.080	V
V <sub>DU</sub>	Overdischarge Release Voltage	V <sub>DU</sub> ≠ V <sub>DL</sub>	V <sub>DU</sub> - 0.150	V <sub>DU</sub>	V <sub>DU</sub> + 0.190	V
		V <sub>DU</sub> = V <sub>DL</sub>	V <sub>DU</sub> - 0.080	V <sub>DU</sub>	V <sub>DU</sub> + 0.080	V
V <sub>DOC</sub>	Discharge Overcurrent Detection Voltage	V <sub>DD</sub> = 3.5V	V <sub>DOC</sub> - 0.030	V <sub>DOC</sub>	V <sub>DOC</sub> + 0.030	V
V <sub>SHORT</sub>	Load Short Detection Voltage	V <sub>DD</sub> = 3.5V	V <sub>SHORT</sub> - 0.10	V <sub>SHORT</sub>	V <sub>SHORT</sub> + 0.10	V
V <sub>COC</sub>	Charge Overcurrent Detection Voltage	V <sub>DD</sub> = 3.5V	V <sub>COC</sub> - 0.040	V <sub>COC</sub>	V <sub>COC</sub> + 0.040	V
I <sub>CC</sub>	Current Consumption during Operation	V <sub>DD</sub> =3.5V, V <sub>M</sub> =0V	—	3.0	7.0	μA
I <sub>STB</sub>	Current Consumption at Standby	V <sub>DD</sub> = 1.8V V <sub>M</sub> Pin Floating	—	6	8	μA
R <sub>VMD</sub>	Resistance between V <sub>M</sub> Pin and V <sub>DD</sub> Pin	V <sub>DD</sub> =1.8V, V <sub>M</sub> =0V	100	300	650	kΩ
R <sub>VMS</sub>	Resistance between V <sub>M</sub> Pin and V <sub>SS</sub> Pin	V <sub>DD</sub> =3.5V, V <sub>M</sub> =1.0V	5	30	65	kΩ
V <sub>0CHA</sub>	0V Battery Charge Starting Charge Voltage	0 V battery charging "available"	1.2	—	—	V
V <sub>0INH</sub>	0V Battery Charge Inhibition Battery Voltage	0 V battery charging "unavailable"	—	—	0.3	V
V <sub>OVCHG</sub>	Overvoltage Charge Detection Voltage	V <sub>DD</sub> =3.5V	5.5	8.0	10.5	V
V <sub>OVCHGR</sub>	Overvoltage Charge Release Voltage	V <sub>DD</sub> =3.5V	5.0	7.3	9.5	V
t <sub>CU</sub>	Overcharge Detection Delay Time	V <sub>CC</sub> =3.6->4.5V	600	1,000	1,400	ms
t <sub>CUR</sub>	Overcharge Release Delay Time	V <sub>M</sub> =0.0V	1.2	2	2.8	ms
t <sub>DL</sub>	Overdischarge Detection Delay Time	V <sub>CC</sub> =3.6->2.0V	69	115	161	ms
t <sub>DLR</sub>	Overdischarge Release Delay Time	V <sub>M</sub> =0.0V	1.2	2	2.8	ms
t <sub>DOC</sub>	Discharge Overcurrent Detection Delay Time	V <sub>CC</sub> =3.6V	6	10	14	ms
t <sub>DOCR</sub>	Discharge Overcurrent Release Delay Time	V <sub>M</sub> =0.0V	1.2	2	2.8	ms
t <sub>SHORT</sub>	Load Short Detection Delay Time	V <sub>CC</sub> =3.6V	216	360	504	μs
t <sub>COC</sub>	Charge Overcurrent Detection Delay Time	V <sub>CC</sub> =3.6V	6	10	14	ms
t <sub>COCR</sub>	Charge Overcurrent Release Delay Time	V <sub>M</sub> =0.0V	1.2	2	2.8	ms

**Performance Characteristics** (Note 9)

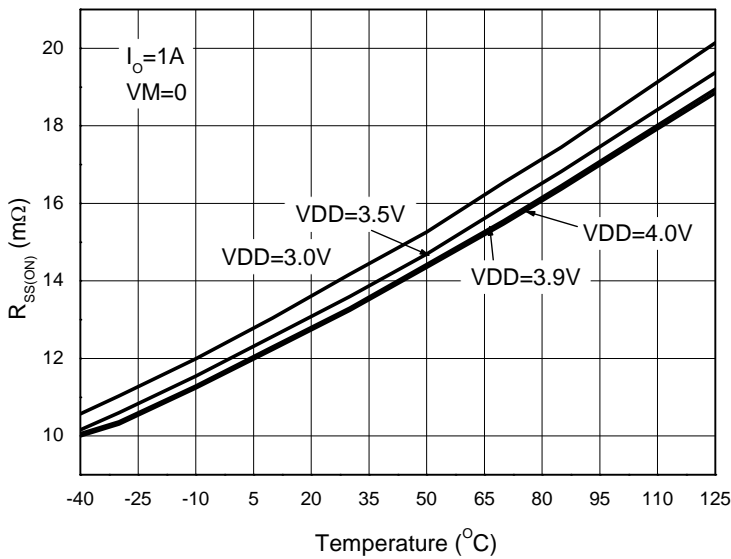

**$R_{SS(ON)}$  Characteristics**

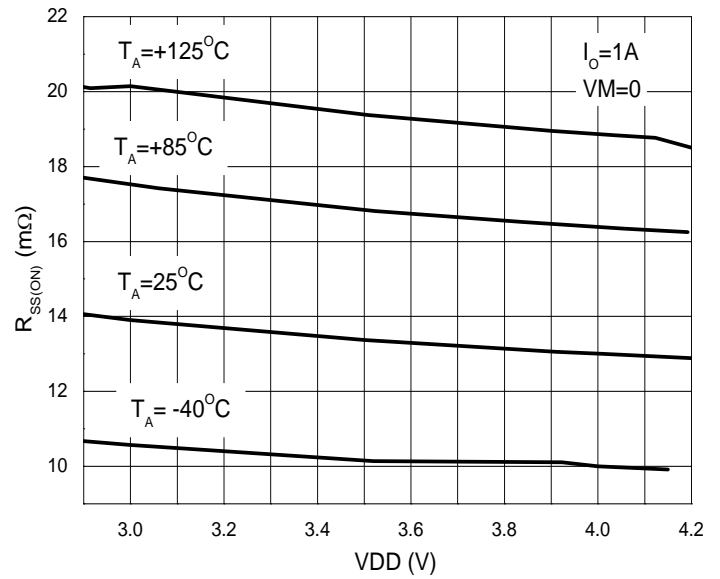

**$R_{SS(ON)}$  Characteristics**

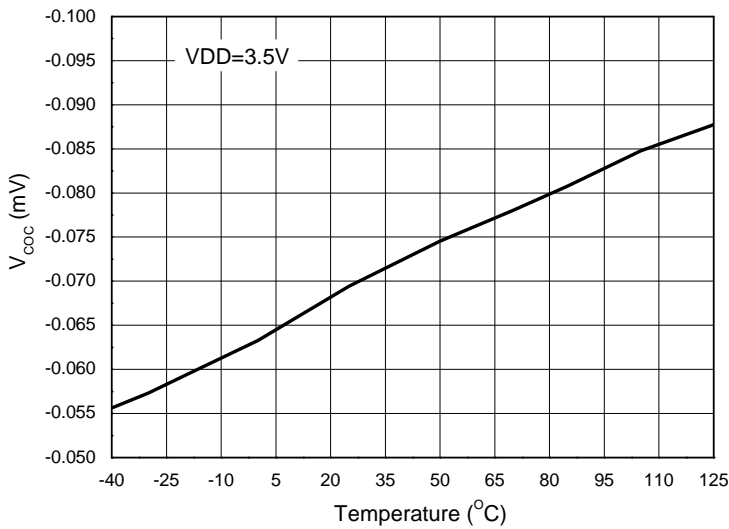

**Charge Overcurrent Detection Voltage**

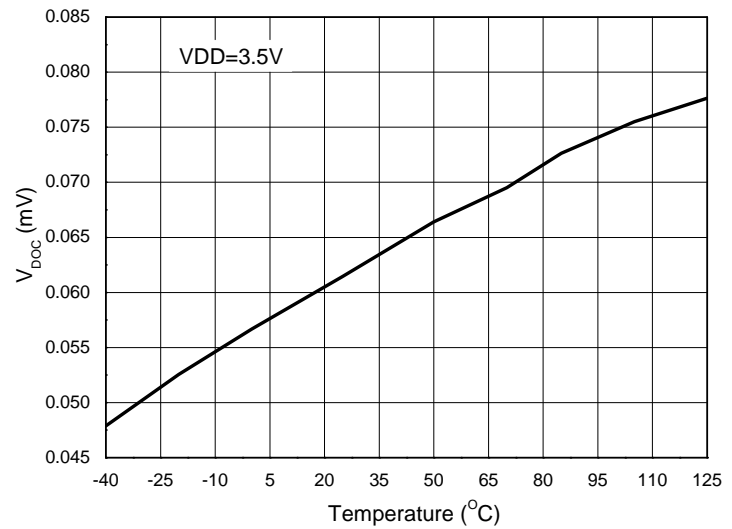

**Discharge Overcurrent Detection Voltage**

Note: 9. Charge/Discharge overcurrent voltage detection are designed to be in accordance with performance of internal MOSFET under full temperature. These specifications are guaranteed by design; will not be tested in production.

## Application Information

### Operation Mode

#### 1. Normal Status

The AP9234L monitors the battery voltage between the  $V_{DD}$  pin and  $V_{SS}$  pin as well as the voltage difference between the  $V_M$  pin and  $V_{SS}$  pin to control battery charging and discharging. When the battery voltage is between overdischarge detection voltage ( $V_{DL}$ ) and overcharge detection voltage ( $V_{CU}$ ) as well as the  $V_M$  pin voltage is between the charge overcurrent detection voltage ( $V_{COC}$ ) and discharge overcurrent detection voltage ( $V_{DOC}$ ), the AP9234L will turn on discharging and charging MOSFET, then the battery can charge and discharge freely in this condition.  $R_{VMD}$  does not connect to  $V_{DD}$  pin and  $R_{VMS}$  does not connect to  $V_{SS}$  pin in this status.

#### 2. Overcharge Status

When the battery voltage is more than  $V_{CU}$  during charging status and the detection lasts for the overcharge detection delay time ( $t_{CU}$ ) or longer, the AP9234L turns off the charging MOSFET to stop charging.  $R_{VMD}$  and  $R_{VMS}$  are not connected in overcharge status.

When  $V_M$  pin voltage is lower than  $V_{DOC}$  and battery voltage falls below  $V_{CL}$ , the AP9234L will release from overcharge status.

When  $V_M$  pin voltage is equal or more than  $V_{DOC}$  and battery voltage falls below  $V_{CU}$ , the AP9234L will release from overcharge status.

#### 3. Overdischarge Status

When the battery voltage is less than  $V_{DL}$  during discharging status and detection continues for the overdischarge detection delay time ( $t_{DL}$ ) or longer, the AP9234L turns off the discharging MOSFET to stop discharging. In overdischarge status,  $R_{VMS}$  is not connected, but  $R_{VMD}$  is connected to  $V_{DD}$  and  $V_M$  pin voltage is pulled up to  $V_{DD}$  by  $R_{VMD}$ .

For power-down mode option (ask local sales office), IC recovers normal status from overdischarge status only by charger charge to battery.

When  $V_M$  pin voltage to  $V_{SS}$  pin voltage is less than typical  $-0.7V$  and the battery voltage rises over  $V_{DL}$ , the AP9234L will release from overdischarge status, if  $V_M$  pin voltage to  $V_{SS}$  pin voltage is higher than typical  $-0.7V$ , the AP9234L will release from overdischarge status until the battery voltage rises over  $V_{DU}$ .

For auto-wake-up version, the AP9234L recovers normal status from overdischarge status requires that either of two conditions should be satisfied.

If charger is connected: The AP9234L overdischarge status is released in the same way as AP9234Ls.

If no charger is connected: 1). The battery voltage reaches the overdischarge release voltage ( $V_{DU}$ ) or higher.

2). Maintains continuous time more than overdischarge release delay time  $t_{DLR}$ .

#### 4. Discharge Overcurrent and Short Current Status

When battery is in discharge overcurrent status, if the voltage of the  $V_M$  pin to  $V_{SS}$  pin is equal or more than  $V_{DOC}$  to  $V_{SHORT}$  and detection lasts for the discharge overcurrent detection delay time ( $t_{DOC}$ ) or longer, the AP9234L turns off the discharging MOSFET to stop discharging.

When the battery is in short current status, if the voltage of the  $V_M$  pin to  $V_{SS}$  pin is equal to or more than  $V_{SHORT}$ , and detection lasts for the short current detection delay time ( $t_{SHORT}$ ) or longer, the AP9234L turns off the discharge MOSFET to stop discharging.

In discharge overcurrent or short current status,  $R_{VMS}$  is connected to  $V_{SS}$  but  $R_{VMD}$  is not connected., the voltage of  $V_M$  pin is almost equal to  $V_{DD}$  as long as the load is connected. When the load is disconnected, the voltage of  $V_M$  pin will become almost equal to  $V_{SS}$ (due to  $R_{VMS}$  being connected) and then the AP9234L will release from discharge overcurrent or short current status.

#### 5. Charge Overcurrent Status

When the battery is in charge overcurrent status, if the voltage of the  $V_M$  pin to  $V_{SS}$  pin is equal to or less than  $V_{COC}$  for the charge overcurrent detection delay time ( $t_{COC}$ ) or longer, the AP9234L turns off the charging MOSFET to stop charging.

#### 6. 0V Battery Charging Function

This function is available as an option and can be factory set internally. AP9234L has this function built in.

0V charging function permits charger to recharge the battery whose voltage is 0V due to self-discharge. If 0V charging function is not present, the device will prevent charger to recharge the battery whose voltage is 0V due to self-discharge. (If a device without 0V charging function is needed, please contact Diodes sales team)

#### 7. Overvoltage Charger Detection Circuit

This function is used to monitor the charger voltage between the  $V_{DD}$  pin and  $V_M$  pin, and when this voltage exceeds overvoltage charger detection voltage (8.0V Typ.), the AP9234L will turn off charging MOSFET, when this voltage drops below overvoltage charger release voltage (7.3V Typ.), it then turns on charging MOSFET. There are no delay times set for detection and release.

#### 8. Power-Down Mode or Auto-Wake-Up Function Option

In device with power-down function, during power-down mode, AP9234L enters overdischarge status. The IC enters sleep mode and the current consumption becomes very low, typically 0.1uA. To release from power-down status to the normal status, charger connection is required.

In device with auto-wakeup mode, the IC remains active in the overdischarge state. The IC is released into the normal state by the operation that increases the battery voltage more than overdischarge release voltage.



**Application Information (Timing Chart)**

**1. Overcharge and Overdischarge Detection**

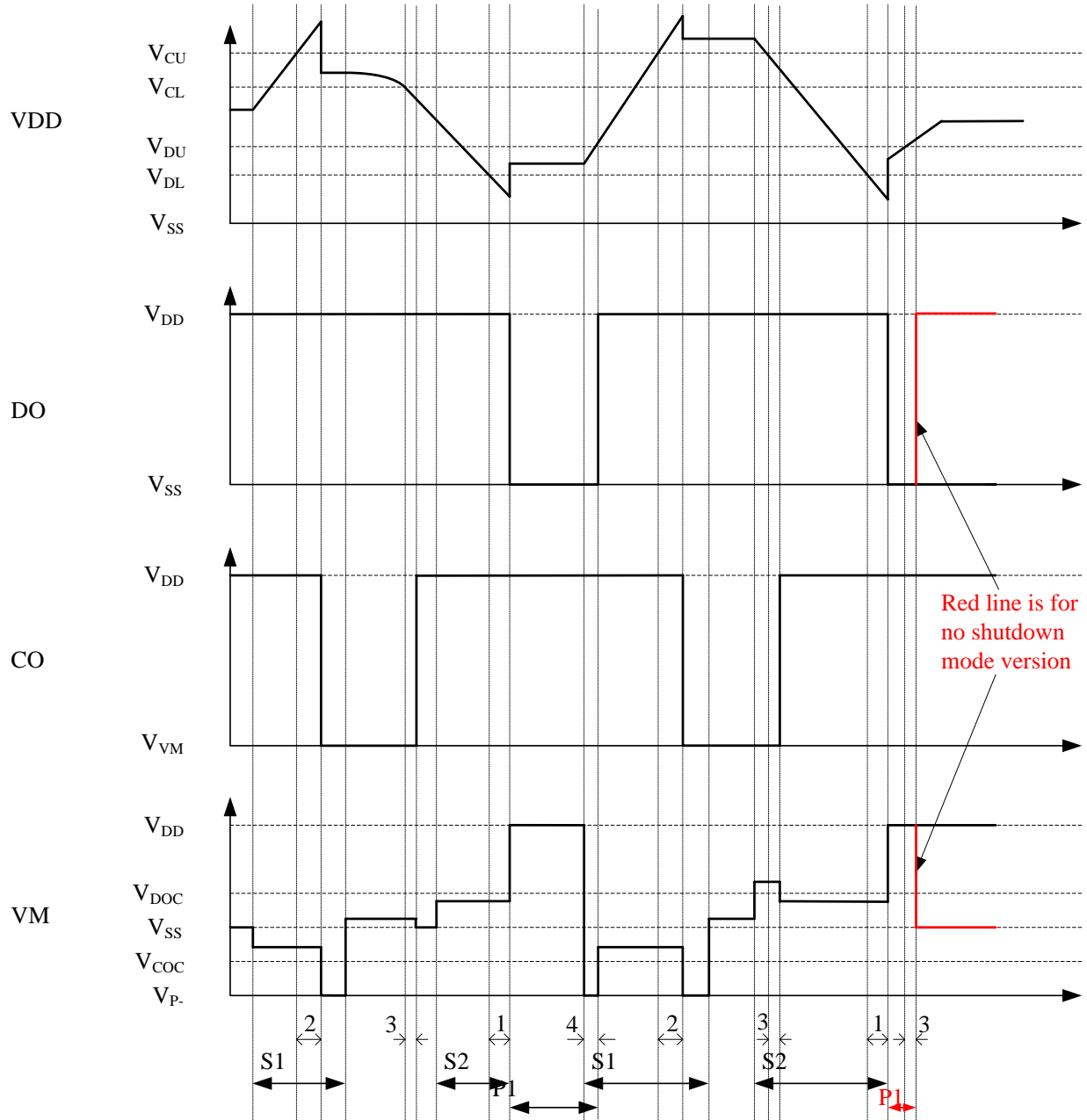

- 1: t<sub>DL</sub>
- 2: t<sub>CU</sub>
- 3: t<sub>CUR</sub>
- 4: t<sub>DLR</sub>

- S1: Charger connection
- S2: Load connection
- P1: R<sub>VMD</sub> pull-up connection

**Application Information (Timing Chart)** (continued)

**2. Discharge Overcurrent Detection**

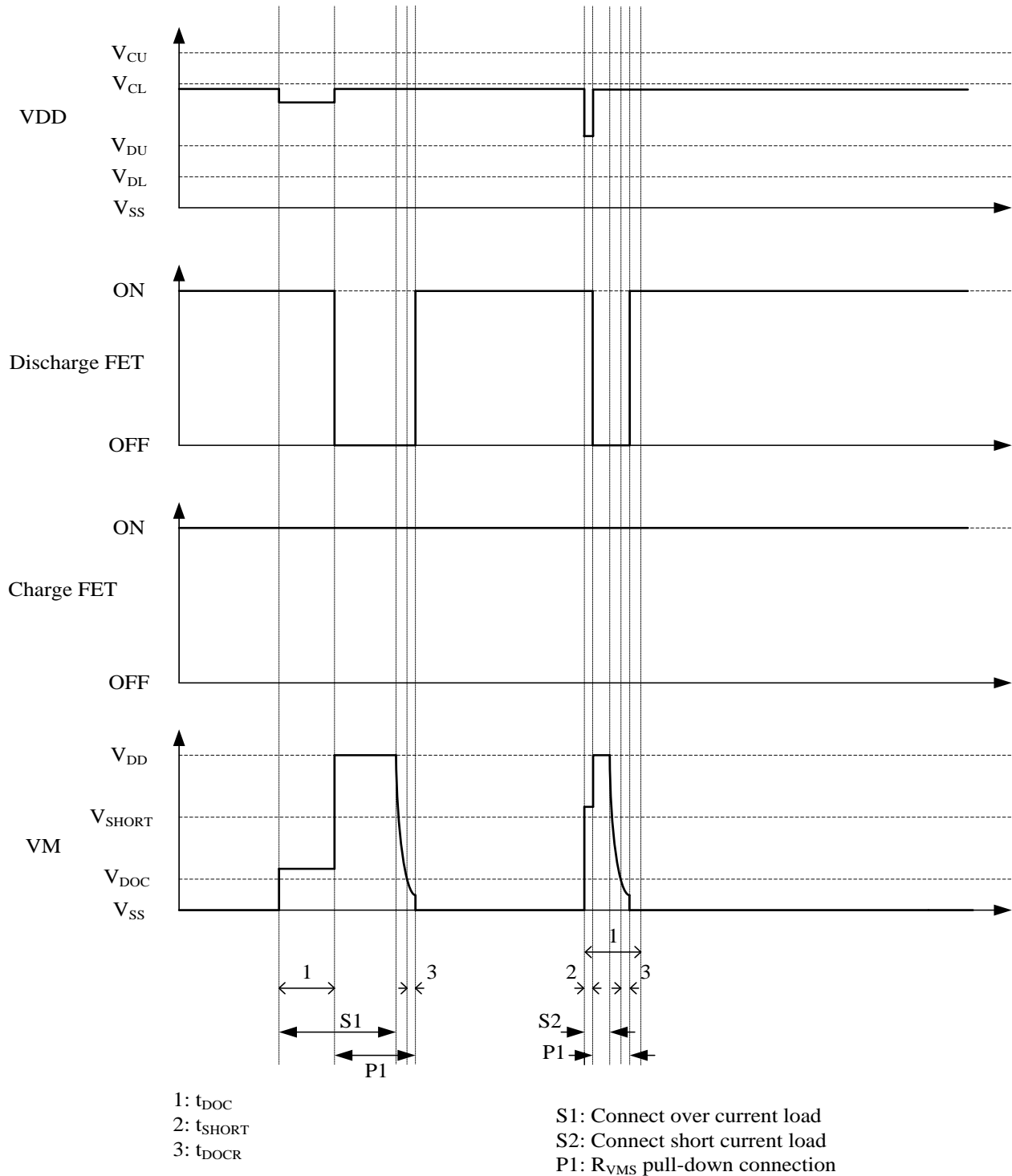

**Application Information (Timing Chart)** (cont.)

**3. Charge Overcurrent Detection**

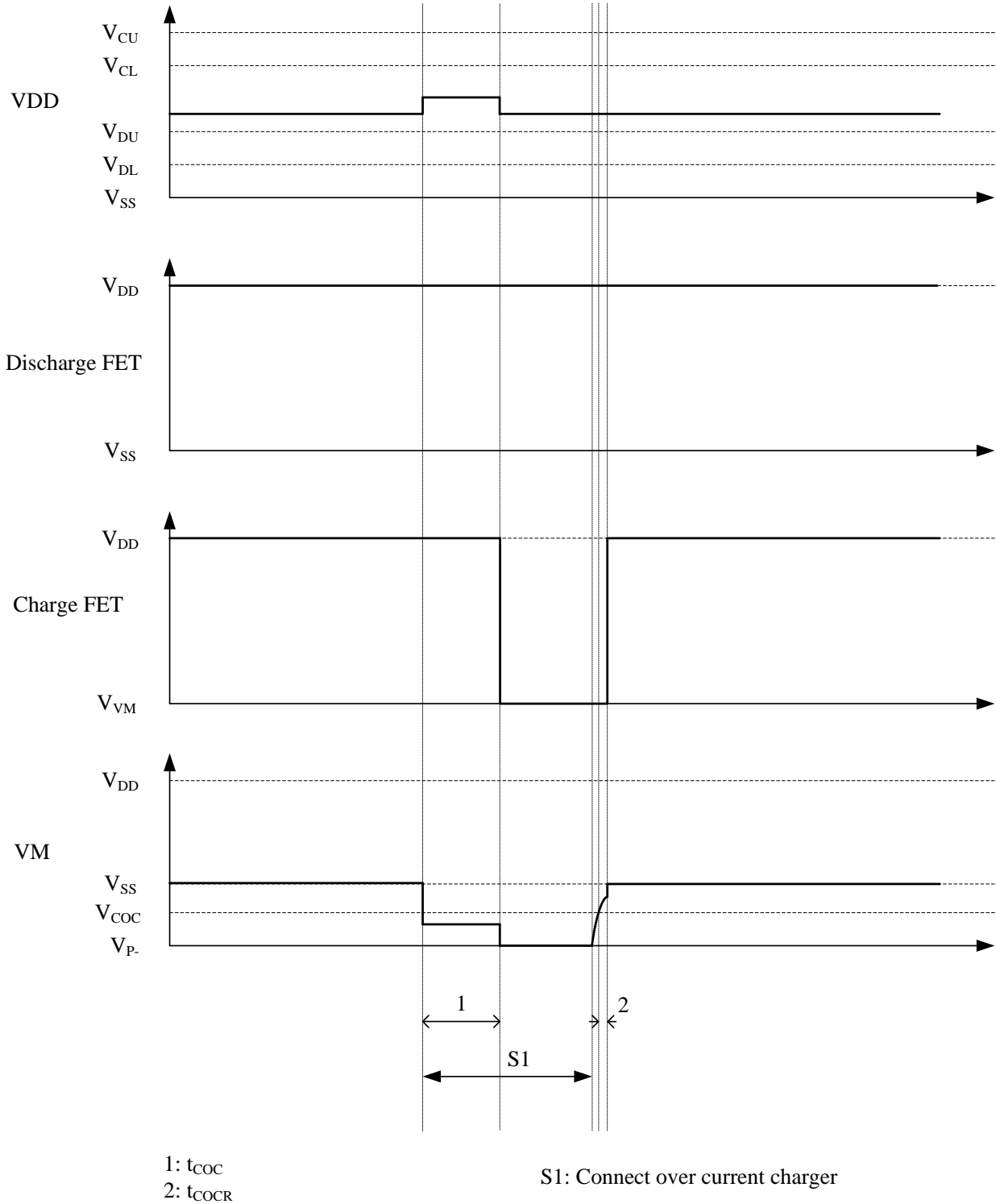

**Ordering Information** (Note 10)

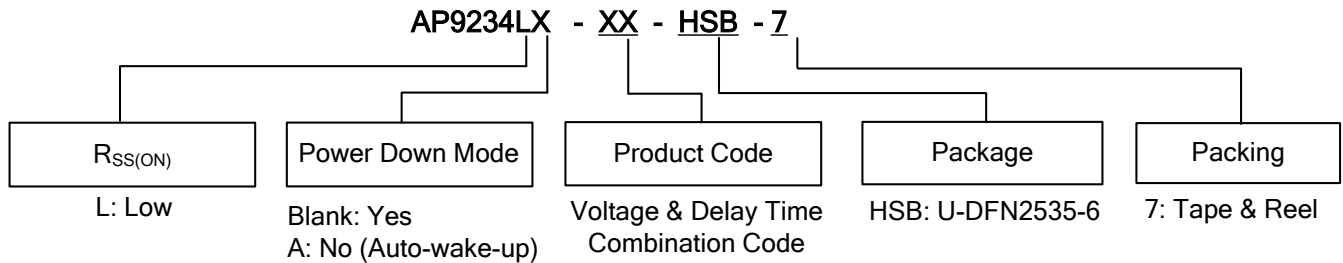

Part Number	Package Code	Packaging	7" Tape and Reel Quantity
AP9234LA-AO-HSB-7	HSB	U-DFN2535-6	3,000/Tape & Reel

**Voltage Combination**

Part Number	Overcharge Detection Voltage V <sub>CU</sub>	Overcharge Release Voltage V <sub>CL</sub>	Over-discharge Detection Voltage V <sub>DL</sub>	Over-discharge Release Voltage V <sub>DU</sub>	Discharge Overcurrent Detection Voltage V <sub>DOC</sub>	Load Short Detection Voltage V <sub>SHORT</sub>	Charge Overcurrent Detection Voltage V <sub>COC</sub>	Over-voltage Charge Detection Voltage V <sub>OVCHG</sub>	Over-voltage Charge Release Voltage V <sub>OVCHGR</sub>	Auto-wake-up Function	Overcharge Protection Mode	0V Battery Charge Function
AP9234LA-AO-HSB-7	4.425V	4.225V	2.500V	2.900V	0.064V	0.228V	-0.073V	8.0V	7.3V	Yes	Auto Release	Permission

**AP9234L Delay Time Combination**

Part Number	Overcharge Detection Delay Time t <sub>CU</sub>	Overcharge Release Delay Time t <sub>CUR</sub>	Overdischarge Detection Delay Time t <sub>DL</sub>	Overdischarge Release Delay Time t <sub>DLR</sub>	Discharge Overcurrent Detection Delay Time t <sub>DOC</sub>	Discharge Overcurrent Release Delay Time t <sub>DOCR</sub>	Charge Overcurrent Detection Delay Time t <sub>COC</sub>	Charge Overcurrent Release Delay Time t <sub>COCR</sub>	Load Short Detection Delay Time t <sub>SHORT</sub>
AP9234LA-AO-HSB-7	1.0s	2.0ms	115ms	2.0ms	10.0ms	2.0ms	10.0ms	2.0ms	360μs

Note: 10. If any other voltage versions or delay time option products are needed, please contact the local sales office.

**Marking Information**

**(Top View)**

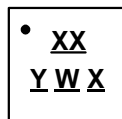

**XX** : Identification Code  
**Y** : Year : 0 to 9  
**W** : Week : A to Z : 1 to 26 week;  
 a to z : 27 to 52 week; z represents  
 52 and 53 week  
**X** : A to Z : Internal code

Part Number	Package	Identification Code
AP9234LA-AO-HSB-7	U-DFN2535-6	34AO

## Package Outline Dimensions

Please see AP02002 at <http://www.diodes.com/datasheets/ap02002.pdf> for the latest version.

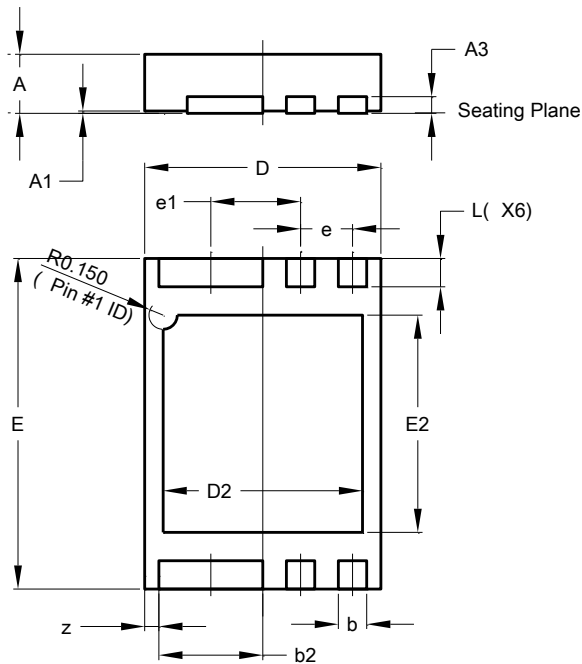

U-DFN2535-6 (Type B)			
Dim	Min	Max	Typ
A	0.50	0.60	-
A1	0.00	0.05	0.02
A3	-	-	0.127
b	0.25	0.35	0.30
b2	1.05	1.15	1.10
D	2.45	2.55	2.50
D2	2.01	2.21	2.11
E	3.45	3.55	3.50
E2	2.20	2.40	2.30
e	-	-	0.55
e1	-	-	0.95
L	0.25	0.35	0.30
z	-	-	0.15
All Dimensions in mm			

## Suggested Pad Layout

Please see AP02001 at <http://www.diodes.com/datasheets/ap02001.pdf> for the latest version.

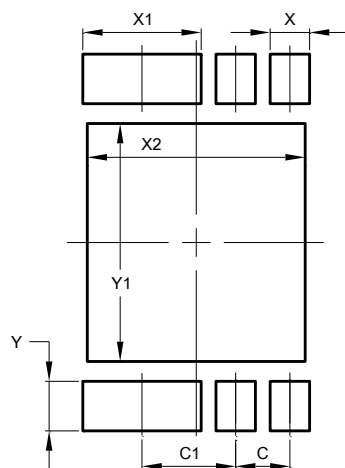

Dimensions	Value (in mm)
C	0.550
C1	0.950
X	0.400
X1	1.200
X2	2.210
Y	0.500
Y1	2.400

**IMPORTANT NOTICE**

DIODES INCORPORATED MAKES NO WARRANTY OF ANY KIND, EXPRESS OR IMPLIED, WITH REGARDS TO THIS DOCUMENT, INCLUDING, BUT NOT LIMITED TO, THE IMPLIED WARRANTIES OF MERCHANTABILITY AND FITNESS FOR A PARTICULAR PURPOSE (AND THEIR EQUIVALENTS UNDER THE LAWS OF ANY JURISDICTION).

Diodes Incorporated and its subsidiaries reserve the right to make modifications, enhancements, improvements, corrections or other changes without further notice to this document and any product described herein. Diodes Incorporated does not assume any liability arising out of the application or use of this document or any product described herein; neither does Diodes Incorporated convey any license under its patent or trademark rights, nor the rights of others. Any Customer or user of this document or products described herein in such applications shall assume all risks of such use and will agree to hold Diodes Incorporated and all the companies whose products are represented on Diodes Incorporated website, harmless against all damages.

Diodes Incorporated does not warrant or accept any liability whatsoever in respect of any products purchased through unauthorized sales channel. Should Customers purchase or use Diodes Incorporated products for any unintended or unauthorized application, Customers shall indemnify and hold Diodes Incorporated and its representatives harmless against all claims, damages, expenses, and attorney fees arising out of, directly or indirectly, any claim of personal injury or death associated with such unintended or unauthorized application.

Products described herein may be covered by one or more United States, international or foreign patents pending. Product names and markings noted herein may also be covered by one or more United States, international or foreign trademarks.

This document is written in English but may be translated into multiple languages for reference. Only the English version of this document is the final and determinative format released by Diodes Incorporated.

**LIFE SUPPORT**

Diodes Incorporated products are specifically not authorized for use as critical components in life support devices or systems without the express written approval of the Chief Executive Officer of Diodes Incorporated. As used herein:

A. Life support devices or systems are devices or systems which:

1. are intended to implant into the body, or
2. support or sustain life and whose failure to perform when properly used in accordance with instructions for use provided in the labeling can be reasonably expected to result in significant injury to the user.

B. A critical component is any component in a life support device or system whose failure to perform can be reasonably expected to cause the failure of the life support device or to affect its safety or effectiveness.

Customers represent that they have all necessary expertise in the safety and regulatory ramifications of their life support devices or systems, and acknowledge and agree that they are solely responsible for all legal, regulatory and safety-related requirements concerning their products and any use of Diodes Incorporated products in such safety-critical, life support devices or systems, notwithstanding any devices- or systems-related information or support that may be provided by Diodes Incorporated. Further, Customers must fully indemnify Diodes Incorporated and its representatives against any damages arising out of the use of Diodes Incorporated products in such safety-critical, life support devices or systems.

Copyright © 2015, Diodes Incorporated

[www.diodes.com](http://www.diodes.com)